



香港  
晶体

Hong Kong X'tals Ltd.  
Hong Kong Automotive X'tals Ltd.



A Kolinker Group Company

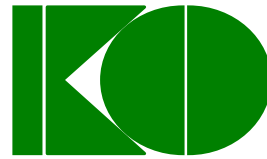

# Kolinker Group Business

Dedicated to the Frequency Products Industry

**Crystal Measurement  
Production Equipment**

**Kolinker Industrial  
Equipments Ltd.**

**Frequency Products  
Manufacturing**

**Hong Kong X'tals Ltd.  
Hong Kong Automotive  
X'tals Ltd.**

**Crystal Raw Material  
Equipment Distribution**

**Kolinker Industrial  
Equipments Ltd.**

## **Kolinker Group Company Profile**

Chairman : Mr. Lee Kam Hung

Capital : HK\$12.40 Million

Kolinker Group Turnover 2007: USD32M

Employee : 800

6 factories in China : 100% self-owned

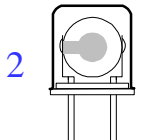

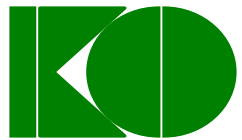

## Equipment & Raw Material Business

since 1983

- Leading Quartz Crystal equipment house
- Measurement standard - Pi Network Measurement
- Papers presented in USA Frequency Symposium & Europe EFTF Conference

**Kolinker**  
Crystal Test & Measurement & Production Equipment

High Through Put

High Efficiency

High Flexibility

### Reference Customers:

#### Crystal manufacturers

NDK, Tokyo Dempa, M-Tron, Raltron, KVG, TEMEX, CEPE, Micro Crystal, Frequency Management ....

#### Crystal Users

Lucent, Alcatel, Beru, TRW, Swissphone Samtagern, Samsung Electronics, Amoisonic, Logitech, CCT Telecom, NPG Monitor, V-Tech, IDT/Tekcom, Picotronics, Orion, Pemstar ...

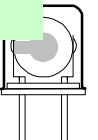

# Production and Sales location

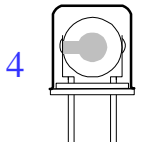

HKC/HKAX Factory



Shenzhen / 深圳

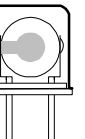

# Products / Monthly capacity

| Factory                        | TS<br>16949 | ISO<br>14000 | 49U/49US<br>Family | Ceramic<br>SMD | Cylinder<br>Type<br>(MHz) | Ceramic<br>Resonator<br>/ Filter | Watch<br>X'tals<br>(KHz) | Total      |
|--------------------------------|-------------|--------------|--------------------|----------------|---------------------------|----------------------------------|--------------------------|------------|
| <b>1 - Shenzhen (89)</b>       | Yes         | Plan         | 2M                 | 3M             |                           |                                  | 5M                       | 10M        |
| <b>2 - Zibo (92)</b>           | Yes         | Yes          | 4M                 |                |                           |                                  |                          | 4M         |
| <b>3 - Qingdao (01)</b>        | Yes         | Plan         | 3M                 | 2M             |                           |                                  |                          | 5M         |
| <b>4 - Fujian (02)</b>         |             | Yes          | 5M                 |                | 1M                        |                                  |                          | 6M         |
| <b>5 - Fujian Ceramic (04)</b> |             |              |                    |                |                           | 5M                               |                          | 5M         |
| <b>6 - HK AEC (06)</b>         | Plan        |              |                    | 1M             |                           |                                  |                          | 1M         |
| <b>Total</b>                   |             |              | 14M                | 6M             | 1M                        | 5M                               | 5M                       | <b>31M</b> |

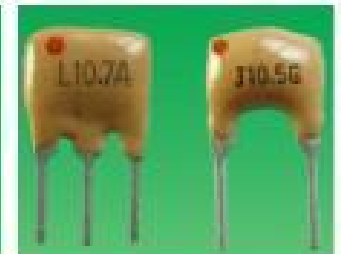
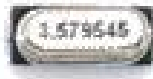

# Frequency Products - Global Sales & Logistic Support

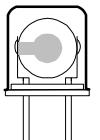
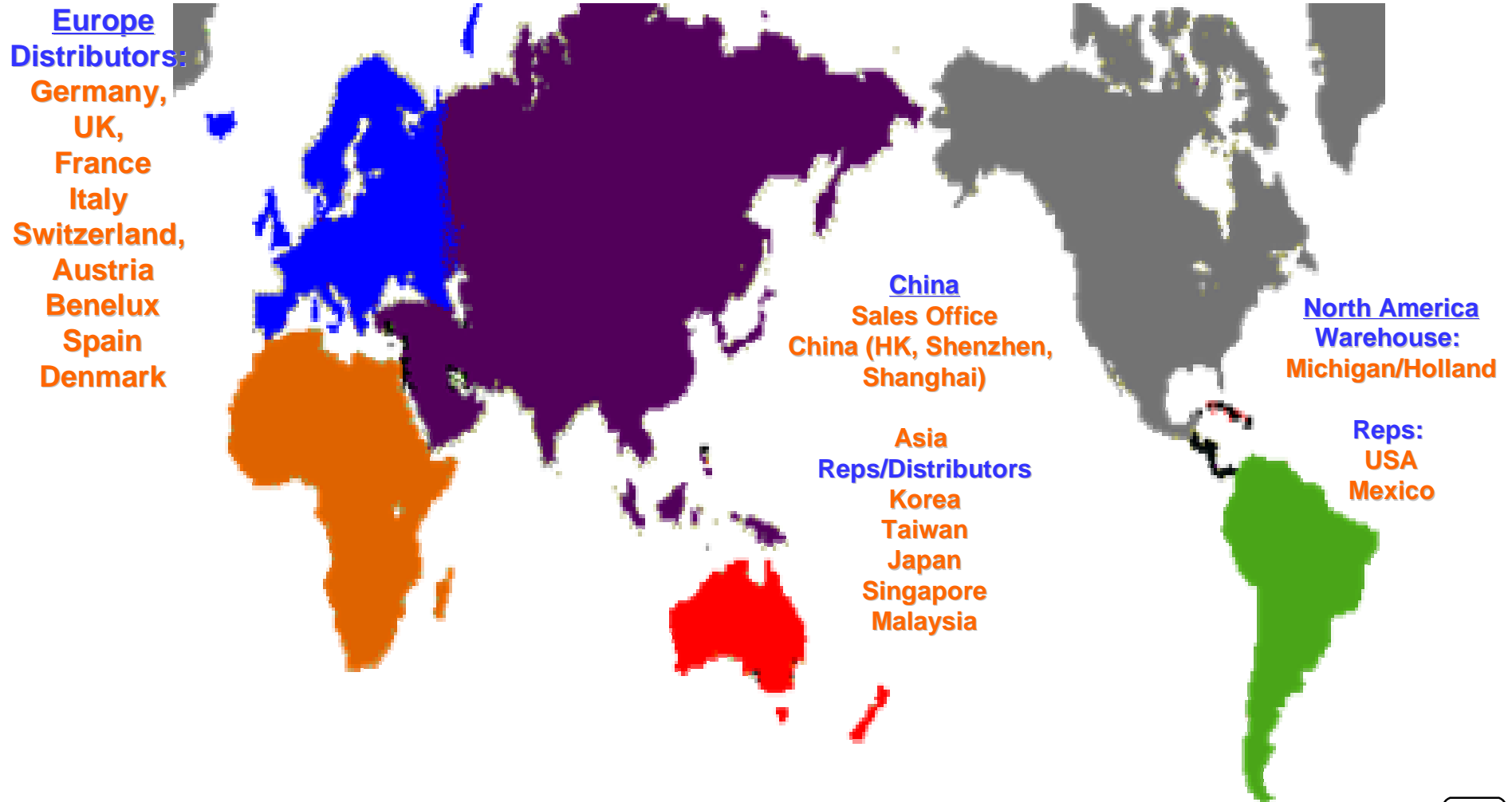

# Frequency Products Business HKC/HKAX 2007

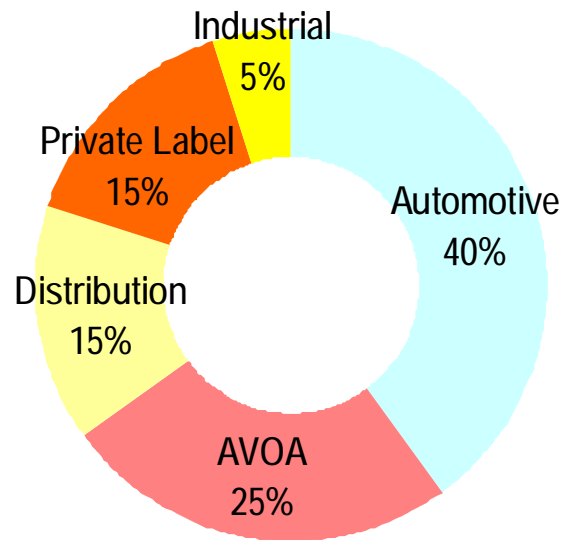

Segment

- Metal Can
- SMD
- TF
- Osc
- CR

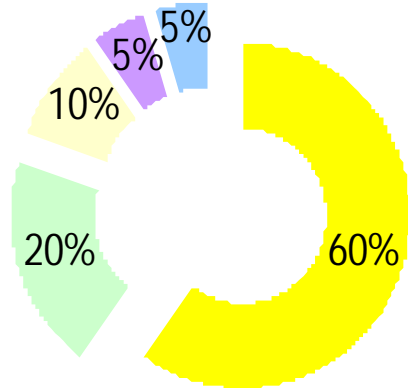

Product Type & Qty

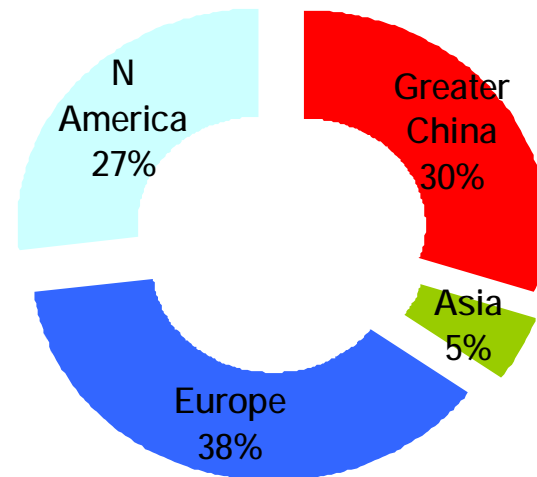

Territory

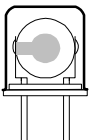



# Technology Road Map

## Crystal

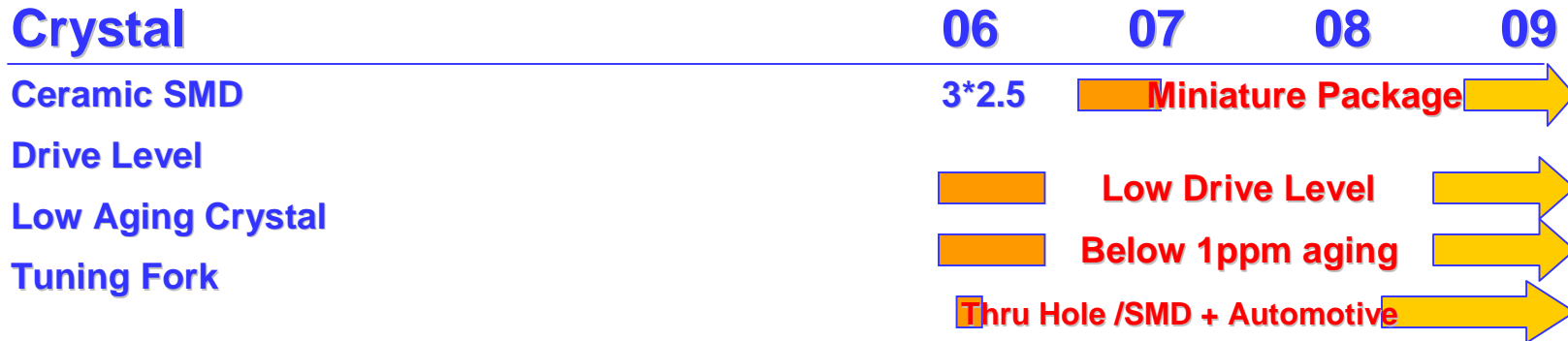

## Oscillators



## Ceramic Resonator



## SAW

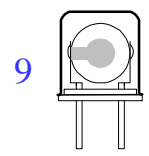

# Hong Kong X'tals Quality Policy

- Quality of a product should include its **RELIABILITY**
- Quality of service should include prompt & accurate **DELIVERY**, and **PROMPT RESPONSE** to CUSTOMERS
- COST **CUTTING** is achieved by continual improving process yield and work efficiency

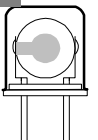



# RoHS / Lead Free Strategies

- **July 1, 2005: All products are Lead Free or RoHS compliant.**
- **For customers who are not ready for change to lead free profile, leaded products are still available but while stock last.**

## Crystals/Oscillator

|                          |  |
|--------------------------|--|
| <b>HC-49U/US - SMD</b>   | <b>: Lead Free and ROHS Compliance</b> |
| <b>Ceramic SMD</b>       | <b>: Lead Free</b>                     |
| <b>Tuning Fork</b>       | <b>: RoHS Compliance (exemption)</b>   |
| <b>Glass Frit</b>        | <b>: RoHS Compliance (exemption)</b>   |
| <br>                     |  |
| <b>Ceramic Resonator</b> | <b>: RoHS Compliance (exemption)</b>   |
| <br>                     |  |
| <b>SAW</b>               | <b>: Lead Free</b>                     |

**Reflow Profile: per type available upon request**

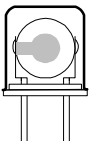

# Reference Customers - Automotive



## In China



## Applications

Electronic Control Systems

Braking Electronics

Steering Electronics

Powertrain Electronics

Safety and Security

Airbag ECU

Occupant Sensing

Car Alarms

Immobilizer

RF TPMS

RKE

Infotainment

Car Audio

DVD

Bluetooth

# Reference Customers – AV OA Communication

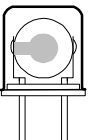

## Reference Customers – Industrial / Power / Whitegoods

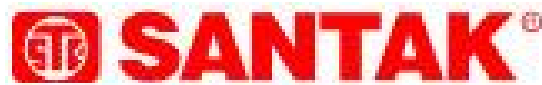

## Reference Customers – Personal Care/Medical

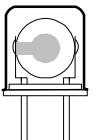

# Technical Support



## *What is a Quartz Crystal ???*



- **Production Engineers :**
  - It is the first component you replace when you have a failure board !
- **Purchasing Officers :**
  - It is a component that you could never get a “reliable” vendor !
- **R&D Engineers :**
  - It is a mysterious little black box !



Hong Kong & Taishan Limited

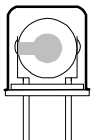

# Technical Support

## Crystal Characterisation

## Crystal Homologation

## Oscillation Margin Test

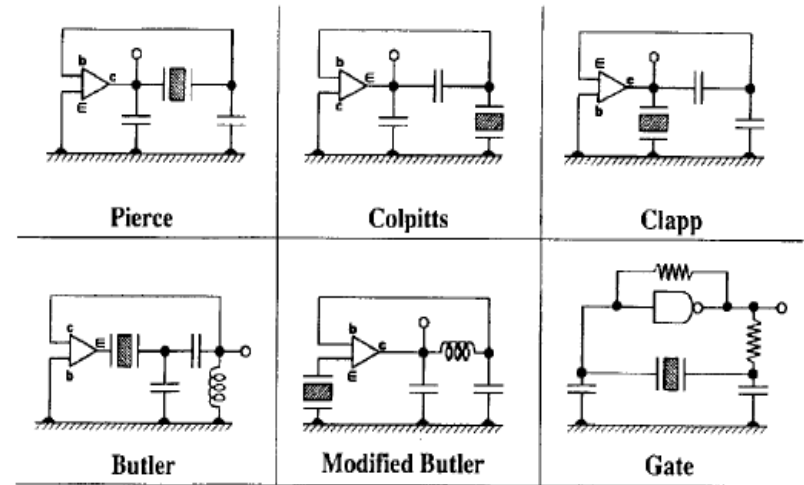

- Measurement of Circuit Characteristics
- Optimal Crystal specification
- Suggestions to Optimise oscillation margin

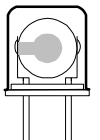
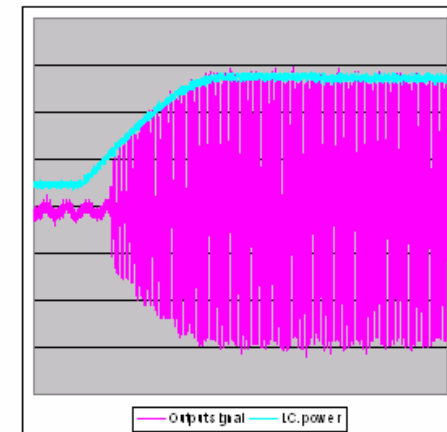
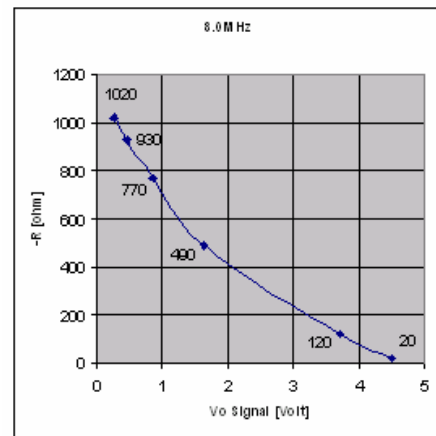
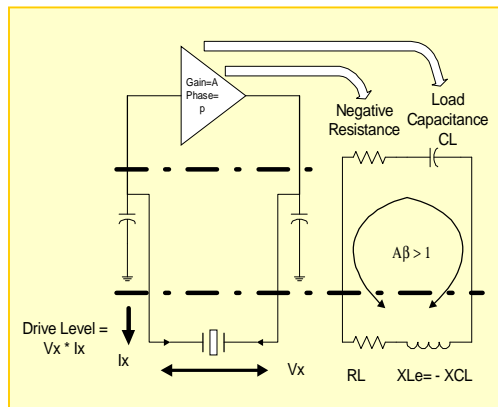



# Technical Support

## II. Crystal Measurement Service

- More than 10 years experience in Crystal Test Measurement
- Equipment complying with EIA 512 & IEC444 international standards
- Capable of measuring all crystal parameters including temperature characteristics, shock and vibration ...
- When necessary, indepth analysis can be provided
- Help identifying / root cause of problems

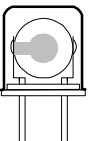

# Technical Support

## III. On site meetings and discussion with Engineering and Purchasing team

- Technical Presentations
  - Sleeping Crystals and DLD (Drive Level Dependency)
  - Direct Impedance Method For Load Resonant Measurement of Crystal
  - Quartz Crystal Reliability and Application
  - Quartz Crystal Industry and What is a Quartz Crystal
  - Temperature characteristics of Quartz Crystals

### Why HKC ?

- HKC focus into your industry !!
- We have the expertise to produce the quality you need.
- We are considerable in company size and capability to offer the support and service that you need.
- We are NOT big enough to ignore any customer.
- We are responsible and open

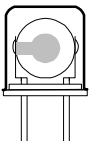

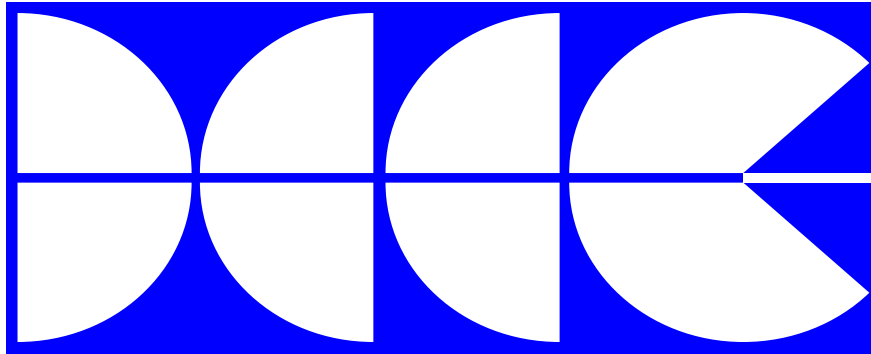

Hong Kong X'tals Ltd  
Hong Kong Automotive X'tals Ltd

**Thank You**

